

RAILMOUNTED TERMINAL BLOCKS — TB60-1120-M

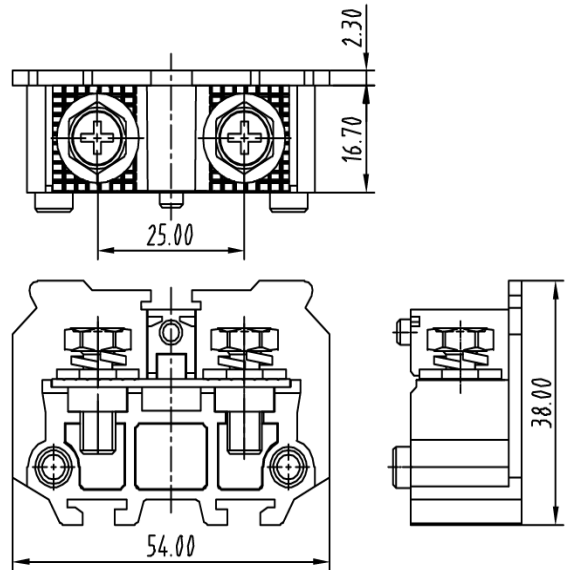

■ 图示(Pic. shown) : TB60-1120-M-K

General:	Railmounted terminal Blocks Rated : 600V,65A , 6AWG
	Single row , 19.0mm pitch , 01 Pole
	Wiring orientation: 180°(wire-to-wire)
	Screw clamp unit: M6.0, 3.0Nm Max

认证 (Approval) :

■ 技术参数 Technical Data	UL standard			IEC standard		
	UL Application group			IEC过电压别/污染等级(IEC overvoltage category /pollution degree)		
UL应用组别(UL Application group)	UL Application group			IEC过电压别/污染等级(IEC overvoltage category /pollution degree)		
IEC过电压别/污染等级(IEC overvoltage category /pollution degree)	B	C	D	III / 3	III / 2	II / 2
额定电压(Rated voltage)	600V	600V	--	--	--	--
额定电流(Rated current)	65A	65A	--	--	--	--
额定连接容量(Rated connection capacity)	18-6AWG Sol&Str			--		
绝缘材料(Insulation Material)				PC V2		
电流承载部件材料和镀层(Material & Plating of Current carrier)				Copper alloy , Ni plated		
接线弹片材料(Material of Clamp spring)				--		
绝缘电阻(Insulation Resistance)				500MΩ or more at DC500V		
耐电压(1分钟)(Withstanding Voltage/1Min)				2500V		
额定冲击电压(Rated surge voltage)				--		
接线螺丝(Wire clamp unit Screw) , 最大扭矩(torque Max.)				M6.0, 3.0Nm Max		
固定螺丝(Mounting Screw) , 扭矩(torque)				--		
剥线长度(Wire stripping length)				--		
使用温度(Operating temperature)				-40°C up to +125°C		
焊接方式(Soldering recommend)				--		

■ 订购方式(How to order)

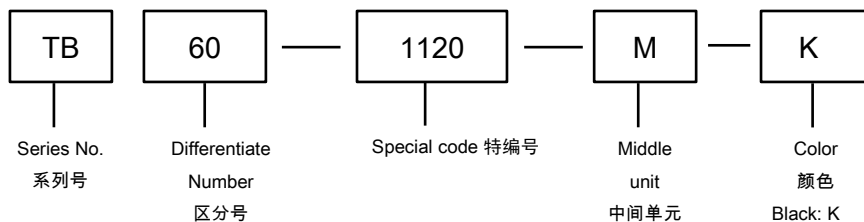

Web:www.china-tianli.com TEL:+86-574-6347-9600,6389-6436 Mail : sale@china-tianli.cn
地址:中国浙江省宁波杭州湾新区庵东工业园区纬三路138号
ADD : 138 , Weisan Rd.,Andong Development Zone, Hangzhou Bay Area, Ningbo, Zhejiang, China

边盖 End Cover



P/N : TB60E-A

配件 ACCESSORIES FOR MODULAR AND RAIL-MOUNTED SERIES



P/N : TH35-7.5-AL-1M

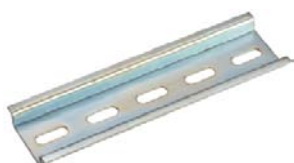
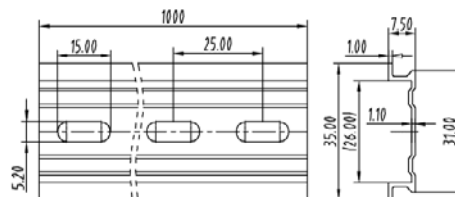

P/N : TH35-7.5-ST-1M

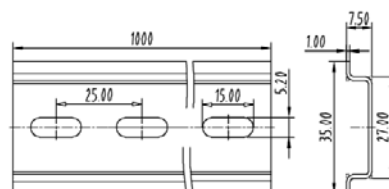

P/N : TBK60

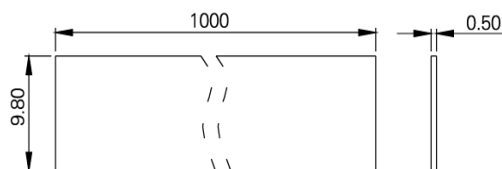

P/N : TBT60

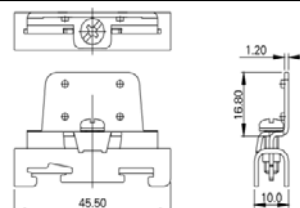

P/N : TB60/80 COVER

